

Sheet Key:

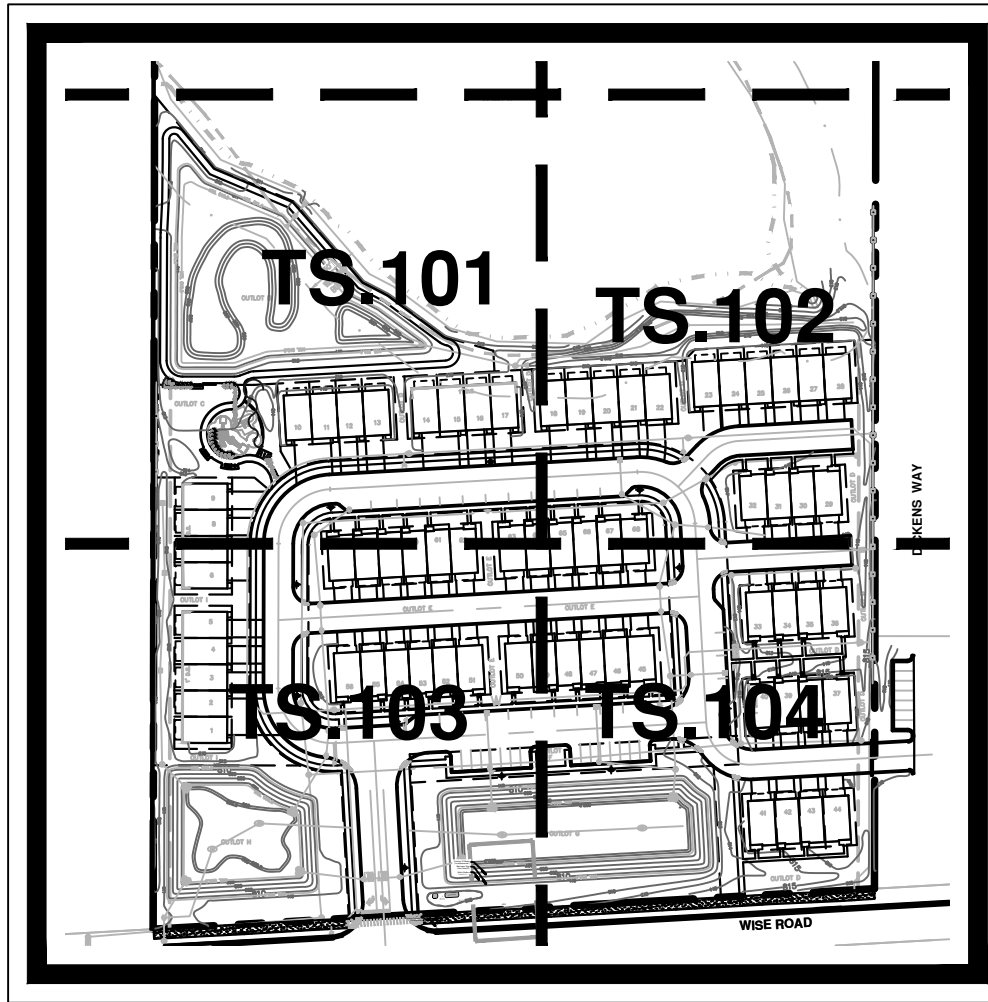

Legend :

- Existing Tree w/ Tag #
- Existing Tree - TO BE SAVED
- Existing Tree - TO BE REMOVED
- Tree Preservation Fencing (Determined at Final)
- Root Pruning (Determined at Final)

General Notes :

- See Sheet TS.105 - TS.106 For Tree Inventory Data
- Tree Preservation In-Progress. Final Preservation is ongoing and will be determined at Final Engineering



Land Planning
Landscape Architecture
Environmental Site Design

132 N. WASHINGTON ST. - NAPERVILLE, IL 60540 - 630.305.3880 Fax 630.305.3994

project:

WISE COMMONS

Wise Road
Schaumburg, Illinois

sheet description:

Existing Tree Survey

owner:



north: scale: 1" = 40' 0"

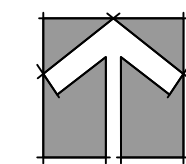

revisions: 8.26.2024 Final Plan Submittal Per Village Review

original issue date: 28 February 2024

drawn by:

checked by:

project no.: 23024



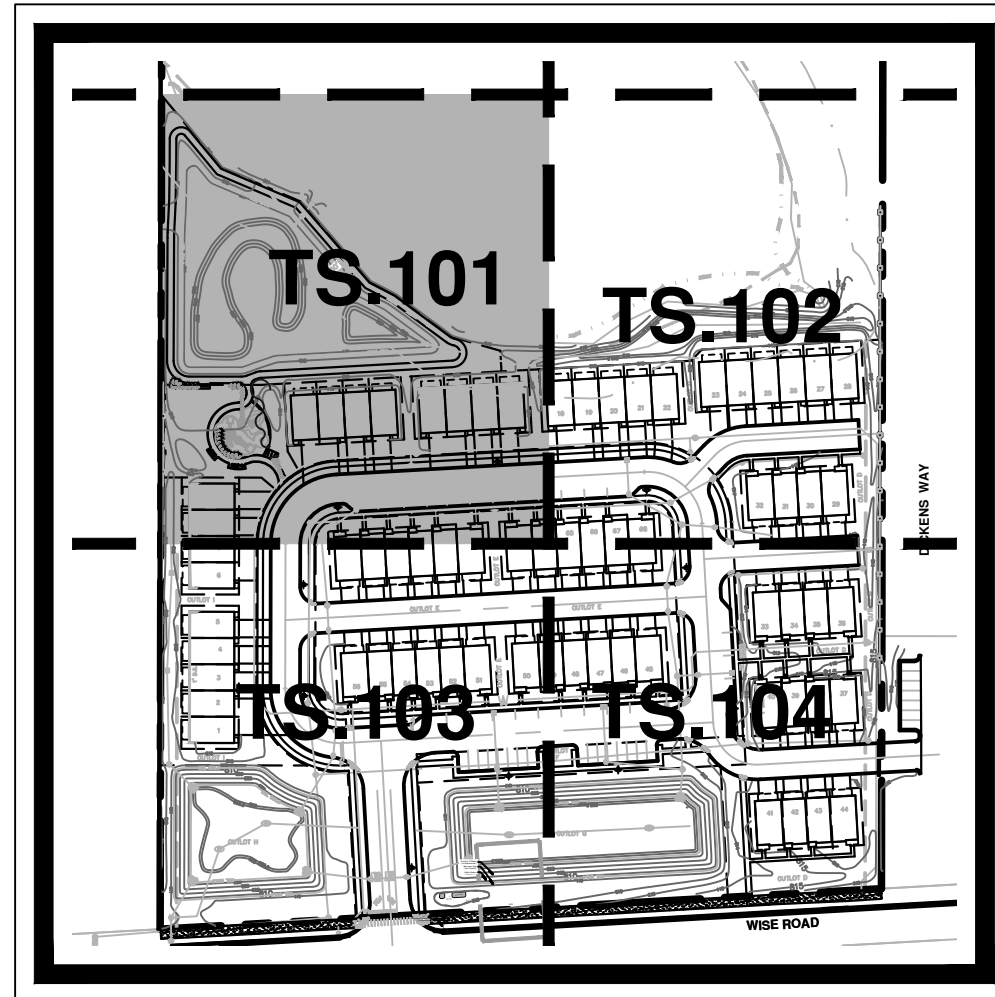

sheet no.:

TS.100

Sheet Key:



Legend :

-  - Existing Tree w/ Tag #
-  - Existing Tree - TO BE SAVED
-  - Existing Tree - TO BE REMOVED
-  - Tree Preservation Fencing (Determined at Final)
-  - Root Pruning (Determined at Final)

General Notes :

- See Sheet TS.105 - TS.106 For Tree Inventory Data
- Tree Preservation In-Progress. Final Preservation is ongoing and will be determined at Final Engineering



Land Planning
Landscape Architecture
Environmental Site Design

132 N. WASHINGTON ST. - NAPERVILLE, IL 60540 - 630.305.3880 Fax 630.305.3894

project:

WISE COMMONS

Wise Road
Schaumburg, Illinois

sheet description:

Existing Tree Survey

owner:



north: scale: 1" = 20' 0"

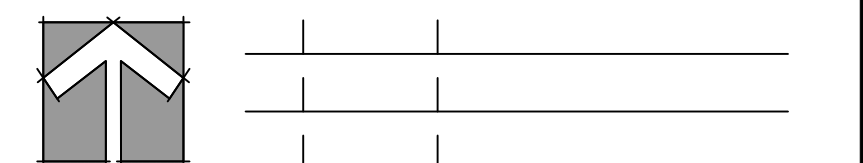

revisions:  8.26.2024 Final Plan Submittal Per Village Review

original issue date: 28 February 2024

drawn by:

checked by:

project no.: 23024



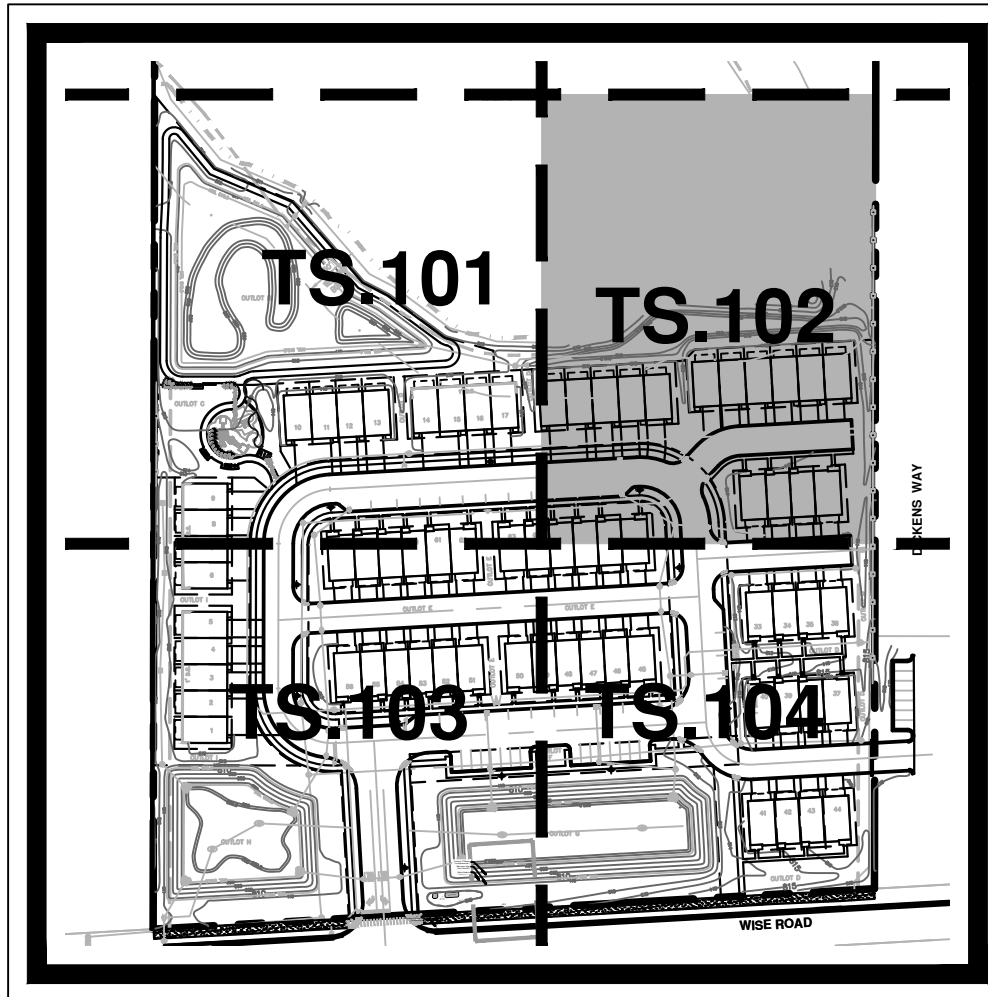

sheet no.:

TS.101

Sheet Key:

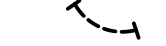

Legend :

-  - Existing Tree w/ Tag #
-  - Existing Tree - TO BE SAVED
-  - Existing Tree - TO BE REMOVED
-  - Tree Preservation Fencing (Determined at Final)
-  - Root Pruning (Determined at Final)

General Notes :

- See Sheet TS.105 - TS.106 For Tree Inventory Data
- Tree Preservation In-Progress. Final Preservation is ongoing and will be determined at Final Engineering



Land Planning
Landscape Architecture
Environmental Site Design

132 N. WASHINGTON ST. - NAPERVILLE, IL 60540 - 630.305.3880 Fax 630.305.3894

project:

WISE COMMONS

Wise Road
Schaumburg, Illinois

sheet description:

Existing Tree Survey

owner:



north: scale: 1" = 20' 0"

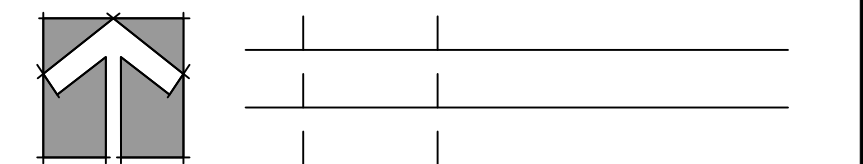

revisions:  8.26.2024 Final Plan Submittal Per Village Review

original issue date: 28 February 2024

drawn by:

checked by:

project no.: 23024

sheet no.:

TS.102

Sheet Key:

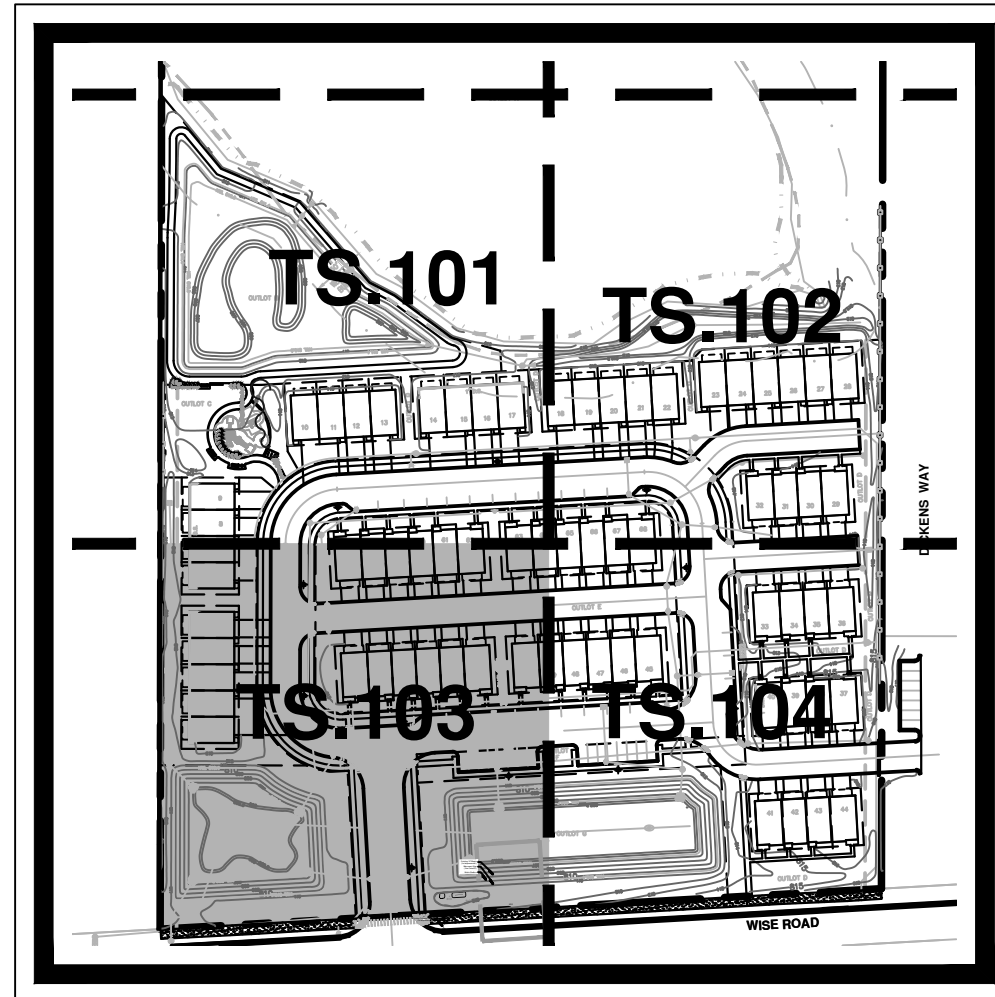

Legend :

- Existing Tree w/ Tag #
- Existing Tree - TO BE SAVED
- Existing Tree - TO BE REMOVED
- Tree Preservation Fencing (Determined at Final)
- Root Pruning (Determined at Final)

General Notes :

- See Sheet TS.105 - TS.106 For Tree Inventory Data
- Tree Preservation In-Progress. Final Preservation is ongoing and will be determined at Final Engineering

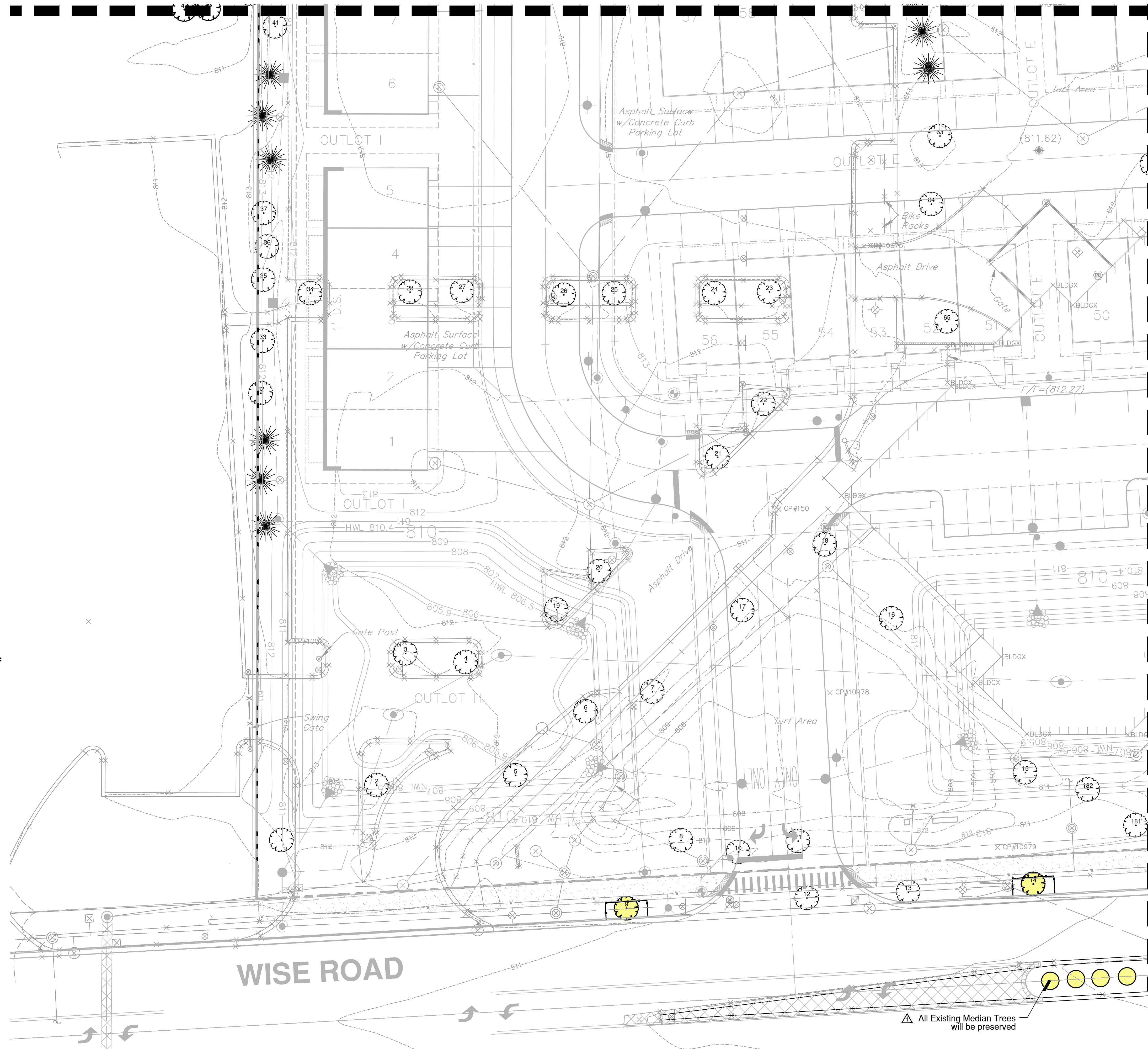

Land Planning
Landscape Architecture
Environmental Site Design

132 N. WASHINGTON ST. - NAPERVILLE, IL 60540 - 630.305.3880 Fax 630.305.3994

project:

WISE COMMONS

Wise Road
Schaumburg, Illinois

sheet description:

Existing Tree Survey

owner:



north: scale: 1" = 20' 0"

revisions:	date	description
	8.26.2024	Final Plan Submittal Per Village Review

original issue date: 28 February 2024

drawn by:
checked by:
project no.: 23024
sheet no.:

TS.103

Sheet Key:

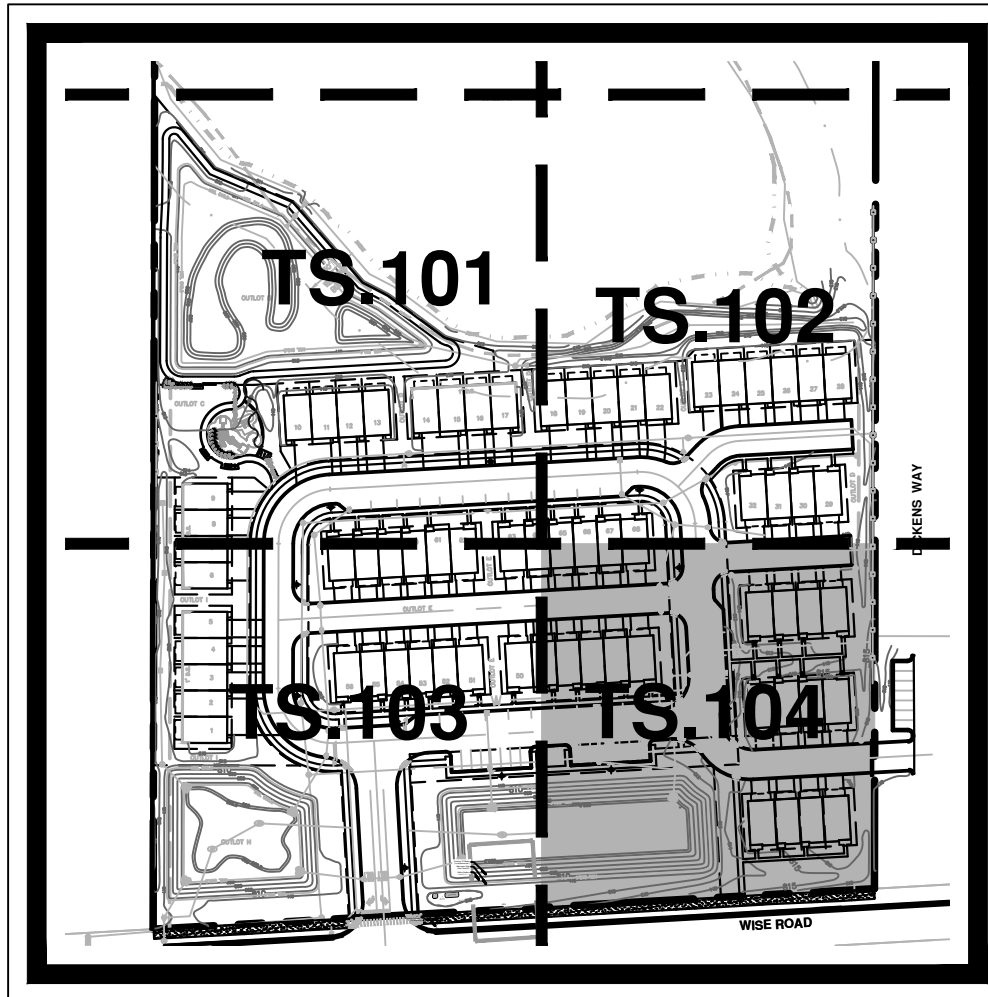

Legend :

- Existing Tree w/ Tag #
- Existing Tree - TO BE SAVED
- Existing Tree - TO BE REMOVED
- Tree Preservation Fencing (Determined at Final)
- Root Pruning (Determined at Final)

General Notes :

- See Sheet TS.105 - TS.106 For Tree Inventory Data
- Tree Preservation In-Progress. Final Preservation is ongoing and will be determined at Final Engineering



Land Planning
Landscape Architecture
Environmental Site Design

132 N. WASHINGTON ST. - NAPERVILLE, IL 60540 - 630.305.3880 Fax 630.305.3994

project:

WISE COMMONS

Wise Road
Schaumburg, Illinois

LO⁺
ALEXAND
PER DOC

sheet description:

Existing Tree Survey

owner:



north: scale: 1" = 20' 0"

↑	

revisions: 8.26.2024 Final Plan Submittal Per Village Review

original issue date: 28 February 2024

drawn by:

checked by:

project no.: 23024

sheet no.:

TS.104



TAG #	Species	DBH	Condition	Comments	Save / Remove	Rep. Required
1	Hawthorn	10	Good		REMOVE	
2	Callery Pear	4x2	Good		REMOVE	
3	Honey Locust	6	Good		REMOVE	
4	Honey Locust	6	Good		REMOVE	
5	Maple	8	Excellent		REMOVE	
6	Callery Pear	5x3	Fair		REMOVE	
7	Maple	11	Good		REMOVE	
8	Maple	14	Good		REMOVE	
9	Honey Locust	8	Good		SAVE	
10	Maple	7	Good		REMOVE	
11	Maple	12	Good		REMOVE	
12	Honey Locust	11	Good		REMOVE	
13	Honey Locust	10	Good		REMOVE	
14	Honey Locust	10	Good		SAVE	
15	Maple	10	Good		REMOVE	
16	Crimson King Maple	11	Excellent		REMOVE	
17	Crimson King Maple	10	Excellent		REMOVE	
18	Maple	14	Good		REMOVE	
19	Honey Locust	7	Good		REMOVE	
20	Honey Locust	10	Good		REMOVE	
21	Honey Locust	10	Good		REMOVE	
22	Honey Locust	9	Good		REMOVE	
23	Honey Locust	7	Good		REMOVE	
24	Honey Locust	5	Good		REMOVE	
25	Honey Locust	9	Good		REMOVE	
26	Honey Locust	8	Good		REMOVE	
27	Honey Locust	6	Good		REMOVE	
28	Honey Locust	5	Good		REMOVE	
29	Douglas Fir	8	Fair		REMOVE	
30	Douglas Fir	8	Fair		REMOVE	
31	Douglas Fir	9	Fair		REMOVE	
32	Crab Apple	10	Fair		REMOVE	
33	Crab Apple	11	Fair		REMOVE	
34	Honey Locust	9	Good		REMOVE	
35	Crab Apple	10	Poor		REMOVE	
36	Crab Apple	10	Fair		REMOVE	
37	Crab Apple	10	Poor		REMOVE	
38	Douglas Fir	10	Fair		REMOVE	
39	Douglas Fir	9	Fair		REMOVE	
40	Douglas Fir	7	Fair		REMOVE	
41	Linden	10	Excellent		REMOVE	
42	Mulberry	13	Good		REMOVE	
43	Buckthorn	6x3	Fair		REMOVE	
44	Buckthorn	2x8	Poor	leaning	REMOVE	
45	Buckthorn	10x3	Poor		REMOVE	
46	Linden	10	Excellent		REMOVE	
47	Linden	14	Excellent		REMOVE	
48	Austrian Pine	14	Fair		REMOVE	
49	Austrian Pine	14	Fair		REMOVE	
50	Austrian Pine	15	Fair		REMOVE	
51	Linden	11	Excellent		REMOVE	
52	Linden	12	Excellent		REMOVE	
53	Honey Locust	5	Good		REMOVE	
54	Honey Locust	5	Good		REMOVE	
55	Honey Locust	5	Good		REMOVE	
56	Honey Locust	6	Good		REMOVE	
57	Honey Locust	4	Good		REMOVE	
58	Honey Locust	4	Good		REMOVE	
59	Douglas Fir	6	Fair		REMOVE	
60	Douglas Fir	7	Good		REMOVE	
61	Douglas Fir	10	Good		REMOVE	
62	Douglas Fir	10	Good		REMOVE	
63	Honey Locust	14	Good		REMOVE	
64	Maple	5	Fair		REMOVE	
65	Crab Apple	3	Good	leaning	REMOVE	
66	Spruce	5	Good		REMOVE	
67	Silver Maple	2x30	Fair		REMOVE	
68	Linden	12	Good		REMOVE	
69	Black Cherry	14	Fair		REMOVE	
70	Black Cherry	10	Fair		REMOVE	
71	Black Cherry	8	Fair		REMOVE	
72	Black Cherry	2x10	Fair		REMOVE	
73	Black Cherry	9	Fair		REMOVE	
74	Black Cherry	7	Fair		REMOVE	
75	Black Cherry	2x8	Fair		REMOVE	
76	Black Cherry	8	Fair		REMOVE	
77	Linden	10	Good		REMOVE	
78	Spruce	9	Good		REMOVE	
79	Red Maple	10	Fair		REMOVE	
80	Red Maple	8	Fair		REMOVE	
81	Black Cherry	11	Fair		REMOVE	
82	Black Cherry	8	Fair		REMOVE	
83	Black Cherry	7	Poor		REMOVE	
84	Mulberry	3x14	Fair		REMOVE	
85	Black Cherry	2x8	Fair		REMOVE	
86	Black Cherry	9	Fair		REMOVE	
87	Mulberry	16	Fair		REMOVE	
88	Mulberry	11	Fair		REMOVE	
89	Red Maple	7	Fair		REMOVE	
90	Mulberry	24	Poor		REMOVE	
91	Callery Pear	14	Fair		REMOVE	
92	Callery Pear	12	Fair		REMOVE	
93	Black Cherry	9	Fair		REMOVE	
94	Black Cherry	10	Poor		REMOVE	
95	Mulberry	20	Fair		REMOVE	
96	Black Cherry	6	Poor		REMOVE	
97	Black Cherry	7	Fair		REMOVE	
98	Black Cherry	9	Fair		REMOVE	
99	Black Cherry	11	Fair		REMOVE	
100	Mulberry	11	Fair		REMOVE	

TAG #	Species	DBH	Condition	Comments	Save / Remove	Rep. Required
101	Mulberry	8	Fair		REMOVE	
102	Mulberry	15	Fair		REMOVE	
103	Maple	16	Good		REMOVE	
104	Maple	12	Fair		REMOVE	
105	Mulberry	13	Fair		REMOVE	
106	Red Oak	4x6	Fair		REMOVE	
107	Spruce	7	Good		REMOVE	
108	Black Alder	6	Good		REMOVE	
109	Black Alder	10	Fair		REMOVE	
110	Black Alder	2x8	Fair		REMOVE	
111	Silver Maple	4x2	Fair		REMOVE	
112	Black Alder	2x7	Good		REMOVE	
113	Black Alder	6x3	Good		REMOVE	
114	Green Ash	4x6	Dead		REMOVE	
115	Callery Pear	8	Fair		REMOVE	
116	Mulberry	6	Fair		REMOVE	
119	Buckthorn	6	Fair		REMOVE	
121	River Birch	4x8	Good		REMOVE	
122	River Birch	4x8	Good		REMOVE	
123	White Pine	7	Poor		REMOVE	
124	White Pine	8	Fair		REMOVE	
125	Callery Pear	11	Fair	lost main leader	REMOVE	
126	Callery Pear	11	Good		REMOVE	
127	White Pine	10	Good		REMOVE	
128	Callery Pear	15	Good		REMOVE	
129	White Pine	8	Fair		REMOVE	
130	Callery Pear	11	Good		REMOVE	
131	White Pine	10	Fair		REMOVE	
132	Crab Apple	10	Good		REMOVE	
133	Austrian Pine	14	Poor		REMOVE	
134	Austrian Pine	11	Poor		REMOVE	
135	Callery Pear	18	Good		REMOVE	
136	Honey Locust	9	Good		SAVE	
137	Honey Locust	8	Fair		SAVE	
138	Crab Apple	12	Fair		REMOVE	
139	Austrian Pine	11	Poor		REMOVE	
140	Austrian Pine	11	Poor		REMOVE	
141	Austrian Pine	11	Poor		REMOVE	
142	Crab Apple	8	Fair		REMOVE	
143	Maple	8	Fair		REMOVE	
144	Maple	14	Good		REMOVE	
145	Crab Apple	8	Good		REMOVE	
146	River Birch	3x7	Good		REMOVE	
147	Arborvitae	20 ft.	Good	Screen Hedge	REMOVE	
148	Arborvitae	20 ft.	Good	Screen Hedge	REMOVE	
149	Arborvitae	20 ft.	Good	Screen Hedge	REMOVE	
150	Arborvitae	20 ft.	Good	Screen Hedge	REMOVE	
151	River Birch	5x6	Good		REMOVE	
152	River Birch	3x8	Good		REMOVE	
153	Arborvitae	20 ft.	Good	Screen Hedge	REMOVE	
154	Arborvitae	20 ft.	Good	Screen Hedge	REMOVE	
155	Arborvitae	20 ft.	Good	Screen Hedge	REMOVE	
156	Arborvitae	20 ft.	Good	Screen Hedge	REMOVE	
157	Arborvitae	20 ft.	Good	Screen Hedge	REMOVE	
158	Arborvitae	20 ft.	Good	Screen Hedge	REMOVE	
159	Arborvitae	20 ft.	Good	Screen Hedge	REMOVE	
160	Arborvitae	20 ft.	Good	Screen Hedge	REMOVE	
161	Arborvitae	20 ft.	Good	Screen Hedge	REMOVE	
162	Arborvitae	20 ft.	Good	Screen Hedge	REMOVE	
163	Arborvitae	20 ft.	Good	Screen Hedge	REMOVE	
164	Arborvitae	20 ft.	Good	Screen Hedge	REMOVE	
165	Arborvitae	20 ft.	Good	Screen Hedge	REMOVE	
166	Arborvitae	20 ft.	Good	Screen Hedge	REMOVE	
167	Arborvitae	20 ft.	Good	Screen Hedge	REMOVE	
168	Arborvitae	20 ft.	Good	Screen Hedge	REMOVE	
169	Arborvitae	20 ft.	Good	Screen Hedge	REMOVE	
170	Arborvitae	20 ft.	Good	Screen Hedge	REMOVE	
171	Arborvitae	20 ft.	Good	Screen Hedge	REMOVE	
172	Arborvitae	20 ft.	Good	Screen Hedge	REMOVE	
173	Maple	8	Good		REMOVE	
174	Crab Apple	15	Good		REMOVE	
175	Crab Apple	12	Good		REMOVE	
176	Crab Apple	16	Good		REMOVE	
177	Austrian Pine	10	Fair		REMOVE	
178	Honey Locust	6	Fair		SAVE	
179	Honey Locust	9	Good		REMOVE	
180	Honey Locust	8	Fair		SAVE	
181	Red Bud	10	Poor		REMOVE	
182	Red Bud	11	Good		REMOVE	
184	Austrian Pine	13	Fair	Zimmerman	REMOVE	
185	Austrian Pine	11	Fair	Zimmerman	REMOVE	
186	Austrian Pine	12	Fair	Zimmerman	REMOVE	
187	Austrian Pine	12	Dead	Zimmerman	REMOVE	
188	Mulberry	16	Fair		REMOVE	
190	Buckthorn	6	Poor		REMOVE	
191	Mulberry	12	Fair		REMOVE	
193	Black Cherry	5	Poor		REMOVE	
194	Buckthorn	9	Fair		REMOVE	
195	Mulberry	2x10	Fair		REMOVE	
196	Mulberry	13	Good		REMOVE	
198	Mulberry	2x10	Fair		REMOVE	
199	Mulberry	18	Fair		REMOVE	
204	Mulberry	7	Fair		REMOVE	
205	Buckthorn	5	Fair		REMOVE	
209	Mulberry	10	Fair		REMOVE	
210	Buckthorn	2x6	Fair		REMOVE	
211	Mulberry	11	Fair		REMOVE	
212	Mulberry	7	Fair		REMOVE	
214	Mulberry	19	Good		REMOVE	
215	Mulberry	9	Fair		REMOVE	

TAG #	Species	DBH	Condition	Comments	Save / Remove	Rep. Required
216	Boxelder	4	Fair		REMOVE	
217	Buckthorn	MS	Poor		REMOVE	
218	Silver Maple	18	Fair		REMOVE	
219	Boxelder	6	Dead		REMOVE	
220	Boxelder	2x20	Fair		REMOVE	
222	Boxelder	2x20,8	Fair	leaning	REMOVE	
223	Buckthorn	5	Poor		REMOVE	
224	Silver Maple	13	Fair		REMOVE	
225	Silver Maple	16	Fair		REMOVE	
226	Silver Maple	15	Poor		REMOVE	
227	Silver Maple	32	Good		REMOVE	
227	Silver Maple	32	Good		REMOVE	
228	Silver Maple	6	Poor		REMOVE	
229	Boxelder	4	Fair		REMOVE	
230	Black Locust	5	Poor		REMOVE	
239	Black Locust	14	Fair		REMOVE	
240	Black Locust	12	Fair		REMOVE	
243	Black Locust	10	Good		REMOVE	
244	Black Locust	9	Good		REMOVE	
245	Black Locust	5	Fair		REMOVE	
246	Black Locust	6	Poor		REMOVE	
247	Black Locust	8	Dead		REMOVE	
248	Black Locust	7	Poor		REMOVE	
249	Black Locust	2x12	Fair		REMOVE	
254	Boxelder	10	Fair		REMOVE	
255	Buckthorn	5	Poor		REMOVE	
256	Mulberry	18	Fair		SAVE	
261	Boxelder	8	Fair		REMOVE	
274	Boxelder	20	Good		REMOVE	
275	Buckthorn	3x5	Poor		REMOVE	
276	Black Cherry	2x10	Fair		REMOVE	
278	Buckthorn	2x8	Fair		REMOVE	
279	Black Cherry	2x12	Poor		REMOVE	
280	Buckthorn	MS	Fair		REMOVE	
281	Black Cherry	2x18	Poor		REMOVE	
282	Black Cherry	5	Fair		REMOVE	
283	Black Cherry	7	Poor		REMOVE	
284	Black Cherry	5	Fair		REMOVE	
285	Buckthorn	4	Poor		REMOVE	
287	Black Cherry	9	Dead		REMOVE	
288	Black Cherry	3x16	Dead		REMOVE	
289	Black Cherry	12	Dead		REMOVE	
290	Buckthorn	4x4	Fair		REMOVE	
291	Mulberry	20	Fair		REMOVE	
292	Buckthorn	4	Fair		REMOVE	
293	Mulberry	10	Fair		REMOVE	
294	Black Cherry	5	Poor		REMOVE	
295	Buckthorn	3x4	Good		REMOVE	
296	Buckthorn	4	Fair		REMOVE	
297	Black Cherry	2x8	Good		REMOVE	
298	Buckthorn	4	Fair		REMOVE	
299	Black Walnut	5	Good		REMOVE	
300	Mulberry	16	Fair		REMOVE	

project:

WISE COMMONS

Wise Road
Schaumburg, Illinois

sheet description:

Existing Tree Inventory Table & Notes

owner:



north: scale:

revisions: 8.26.2024 Final Plan Submittal Per Village Review

original issue date: **28 February 2024**

drawn by:

checked by:

project no.: **23024**

sheet no.:

TS.106

TAG #	Species	DBH	Condition	Comments	Save / Remove	Rep. Required
360	Buckthorn	7	Poor	Beyond Work Limit	SAVE	
361	Boxelder	7	Fair	Beyond Work Limit	SAVE	
362	Black Cherry	8	Poor	Beyond Work Limit	SAVE	
363	Boxelder	14	Dead	Beyond Work Limit	SAVE	
364	Boxelder	22	Good	Beyond Work Limit	SAVE	
367	Black Cherry	8	Fair	Beyond Work Limit	SAVE	
368	Mulberry	18	Good	Beyond Work Limit	SAVE	
369	Black Cherry	15	Fair	Beyond Work Limit	SAVE	
370	Black Cherry	10	Fair	Beyond Work Limit	SAVE	
371	Mulberry	10	Fair	Beyond Work Limit	SAVE	
372	Black Cherry	16	Fair	Beyond Work Limit	SAVE	
373	Black Cherry	8	Fair	Beyond Work Limit	SAVE	
374	Black cherry	13	Fair	Beyond Work Limit	SAVE	
375	Buckthorn	7	Fair	Beyond Work Limit	SAVE	
379	Hackberry	26	Excellent	Key Tree	SAVE	
381	Buckthorn	12	Fair	Beyond Work Limit	SAVE	
383	Black cherry	8	Poor	Beyond Work Limit	SAVE	
396	Boxelder	8	Fair	Beyond Work Limit	SAVE	
397	Black Cherry	12	Fair	Beyond Work Limit	SAVE	
398	Mulberry	11	Fair	Beyond Work Limit	SAVE	
399	Mulberry	4	Fair		REMOVE	
400	Black Cherry	5	Fair		REMOVE	
401	Black Cherry	4	Dead		REMOVE	
402	Black Cherry	9	Poor		REMOVE	
403	Buckthorn	11	Fair		REMOVE	
404	Buckthorn	MS	Fair		REMOVE	
406	Mulberry	7	Fair		REMOVE	
407	Buckthorn	MS	Fair		REMOVE	
408	Boxelder	13	Fair		REMOVE	
409	Black Cherry	3x12	Poor		REMOVE	
410	Buckthorn	5	Poor		REMOVE	
412	Black Cherry	2x10	Poor		REMOVE	
413	Buckthorn	9	Fair		REMOVE	
414	Mulberry	6	Fair		REMOVE	
415	Black Cherry	16	Poor		REMOVE	
416	Buckthorn	6	Fair		REMOVE	
417	Black Cherry	13	Fair		REMOVE	
418	Black Cherry	6	Poor		REMOVE	
419	Buckthorn	8	Poor		REMOVE	
420	Mulberry	13	Fair		REMOVE	
421	Buckthorn	12	Fair		REMOVE	
422	Black Cherry	10	Fair		REMOVE	
423	Black Cherry	11	Dead		REMOVE	
424	Black Cherry	2x8	Fair		REMOVE	
427	Black Cherry	10	Poor		REMOVE	
428	Black Cherry	2x12	Fair		REMOVE	
429	Black Cherry	12	Fair		REMOVE	
430	Black Cherry	8	Poor		REMOVE	
431	Black Cherry	8	Fair		REMOVE	
432	Buckthorn	4	Poor		REMOVE	
432	Buckthorn	6	Poor		REMOVE	
433	Black Cherry	18	Fair		REMOVE	
435	Buckthorn	9	Fair		REMOVE	
436	Black Cherry	5	Fair		REMOVE	
437	Black Cherry	12	Dead		REMOVE	
438	Boxelder	30	Fair		REMOVE	
439	Black Cherry	18	Poor		REMOVE	
440	Black Cherry	10	Fair		REMOVE	
441	Mulberry	18	Fair		REMOVE	
442	Black Cherry	19	Fair		REMOVE	
443	Buckthorn	MS	fair		REMOVE	
444	Buckthorn	MS	Poor		REMOVE	
452	Buckthorn	8	fair		REMOVE	
453	Black Cherry	14	Fair		REMOVE	
454	Black Cherry	23	Poor		REMOVE	
455	Buckthorn	2x5	Fair		REMOVE	
456	Buckthorn	5	Poor		REMOVE	
457	Buckthorn	MS	Poor		REMOVE	
457	Buckthorn	MS	Poor		REMOVE	
458	Mulberry	12	Fair		REMOVE	
458	Boxelder	11	Fair		REMOVE	
458	Buckthorn	6	Fair		REMOVE	
459	Buckthorn	5	Poor		REMOVE	
459	Buckthorn	5	Fair		REMOVE	
460	Buckthorn	5	Fair		REMOVE	
460	Buckthorn	5	Fair		REMOVE	
461	Black Cherry	18	Fair		REMOVE	
463	Black Cherry	12	fair		REMOVE	
465	Buckthorn	5	Poor		REMOVE	
466	Mulberry	2x14	Fair	Beyond Work Limit	SAVE	
467	Boxelder	10	fair	Beyond Work Limit	SAVE	
471	Black Cherry	2x14	Fair	Beyond Work Limit	SAVE	
472	Black Cherry	8	Fair	Beyond Work Limit	SAVE	
473	Buckthorn	5	Fair	Beyond Work Limit	SAVE	
484	Black Cherry	20	Poor	Beyond Work Limit	SAVE	
2174	Boxelder	16	Good	Beyond Work Limit	SAVE	
2175	Boxelder	12	Poor	Beyond Work Limit	SAVE	
2176	Black Cherry	20	Fair	Beyond Work Limit	SAVE	
2177	Black Cherry	9	Fair	Beyond Work Limit	SAVE	
2178	Black Cherry	18	Fair	Beyond Work Limit	SAVE	
2183	Boxelder	17	Fair	Beyond Work Limit	SAVE	
2184	Boxelder	16	Poor	Beyond Work Limit	SAVE	
2185	Mulberry	12	Fair	Beyond Work Limit	SAVE	
2186	Boxelder	20	Fair	Beyond Work Limit	SAVE	
2196	Black Cherry	11	Poor	Beyond Work Limit	SAVE	
2197	Black Cherry	6	Fair	Beyond Work Limit	SAVE	
2198	Black Cherry	8	Poor	Beyond Work Limit	SAVE	
2199	Buckthorn	12	Fair	Beyond Work Limit	SAVE	
2200	Boxelder	2x18	Fair	Beyond Work Limit	SAVE	
2202	Buckthorn	9	Fair	Beyond Work Limit	SAVE	

TAG #	Species	DBH	Condition	Comments	Save / Remove	Rep. Required
2203	Black Cherry	21	Fair	Beyond Work Limit	SAVE	
2205	Boxelder	9	Fair	Beyond Work Limit	SAVE	
2206	Boxelder	8	Fair	Beyond Work Limit	SAVE	
2207	Boxelder	11	Fair	Beyond Work Limit	SAVE	
2208	Boxelder	2x8	Fair	Beyond Work Limit	SAVE	
2209	Mulberry	15	Fair	Beyond Work Limit	SAVE	
2220	Black Cherry	22	Fair	Beyond Work Limit	SAVE	
2221	Black Locust	7	Fair	Beyond Work Limit	SAVE	
2223	Black Cherry	18	Poor	Beyond Work Limit	SAVE	
2224	Black Cherry	9	Poor	Beyond Work Limit	SAVE	
2225	Boxelder	10	Poor	Beyond Work Limit	SAVE	
3195	Black Cherry	12	Fair	Beyond Work Limit	SAVE	

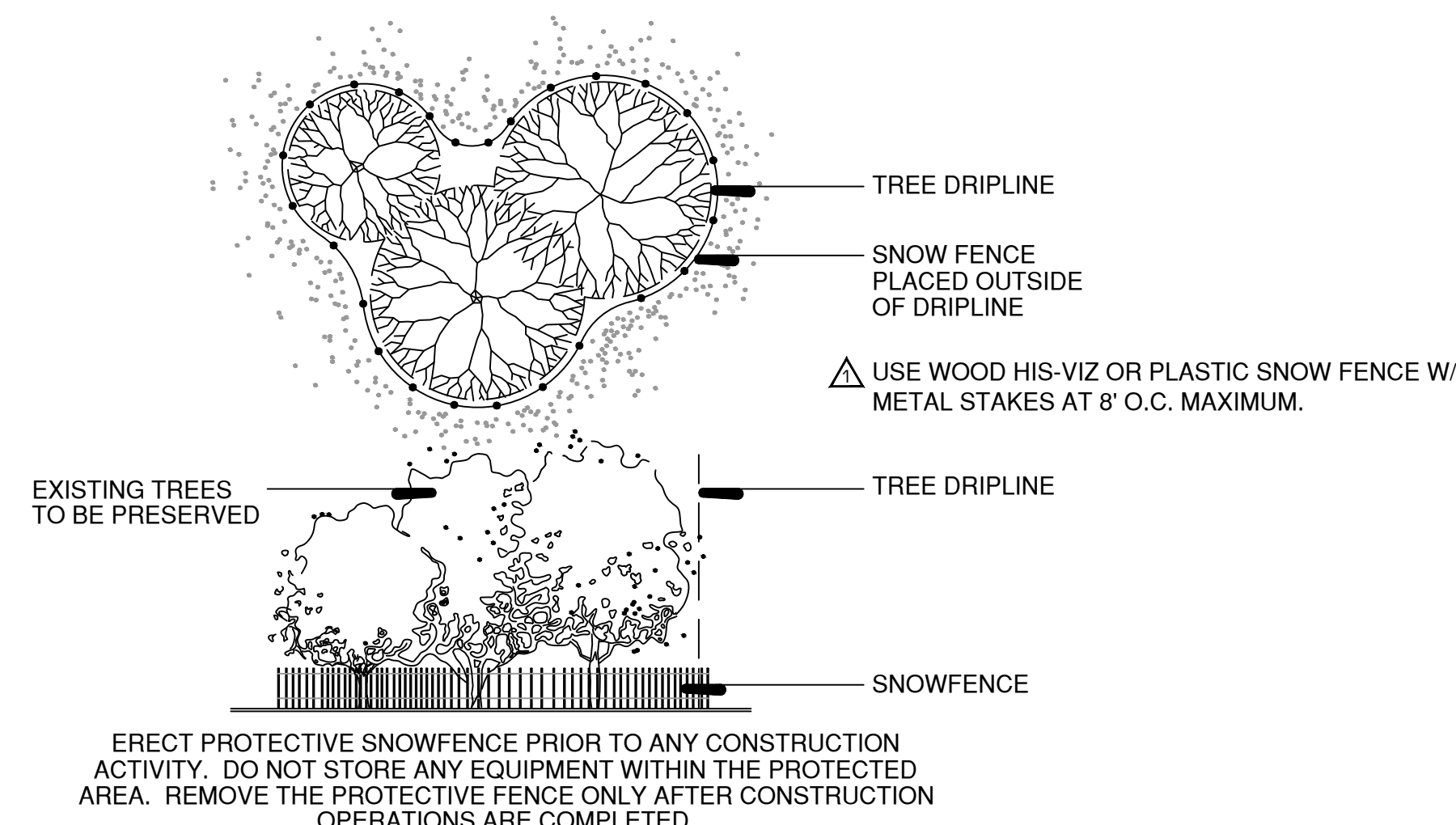

1
A Typical Tree Preservation Fencing
NTS

Tree Preservation Notes :

- Tree Removal Permit Required: A tree removal permit shall be required for the removal of any tree in the woodland. No person shall, directly or indirectly, remove, damage or destroy a woodland without having secured a TRP.
- The Owner or his/her designee shall be responsible for construction and maintenance of temporary fencing or other tree protection measures, to be used during construction.
- Snow fencing shall be temporarily installed at the drip line protection of trees prior to any construction activities and maintained throughout the entire project. The drip line area is the ground under a tree canopy from the trunk to the outmost branches. See detail A Above
- Grading and construction equipment shall be forbidden from encroaching within the drip line of a tree.
- No construction activity, movement, and/or placement of equipment or materials or spoils storage shall be permitted within the drip line of a protected tree or at any higher location where drainage toward the tree could conceivably affect the health of the tree. No excess soil, additional fill, liquids or construction debris shall be placed within the drip line of a protected tree.
- No attachments, fences, or wires, other than those approved for bracing, guying or wrapping, shall be attached to trees during the construction period.
- Grade change shall be allowed under the drip line of any trees designated for preservation only if tree trunks and branches are protected when construction must occur within tree drip line areas.
- To improve the survival rate of trees, root pruning and/or thinning shall be performed in accordance with industry standards and practices and where indicated on the plan.

Tree Survey Date :

Existing tree inventory and rating completed by Signature Design Group from October 30 - November 4, 2024. Follow-up inventory completed on February 3, 2024. Location Survey and Tree Sizing Plan prepared by CEMCON, Ltd. in 2023.

Condition Rating Key :

Rating	Description	General Criteria
5	Excellent	The tree is typical of the species, has less than 10% deadwood in the crown that is attributable to normal causes, has no other observed problems, and requires no remedial action
4	Good	The tree is typical of the species and / or has less than 20% deadwood in the crown, only 1 or 2 minor problems that are easily corrected with normal care.
3	Fair	The tree is typical of the species and / or has less than 40% deadwood in the crown, only 1 or 2 minor problems that are not immediately lethal to the tree and no significant decay or significant structural problems, but the tree must have remedial care above normal care in order to minimize the impact of future stress and to ensure continued health.
2	Poor	The tree is not typical of the species and / or has over 50% deadwood in the crown, major decay or structural problems, is hazardous or is severely involved with insects, disease, or other problems that even if aggressively corrected would not result in the long term survival of the tree.
1	Dead	Less than 10% of the tree shows signs of life